

# Boom M

## Recessed Downlight

Introducing ceiling-recessed downlight that highlight the desired subject or place and provide optimum illumination by being nondescript.

The simplicity of its form provides smooth integration in architectural features.



### Product Specs :

Model name :	Boom M Recessed Downlight
Weight:	1.4Kg
Certificate Available:	Self Declaration Certificates
Colors Available:	Black / White
System Lumen:	3278 lm
System Wattage:	40 W
DC Current:	1050 mA
Efficacy:	81 lm/W
CCT(K) :	3500K
CRI:	> 90
Bining:	≤3SDCM
Lifetime:	L80/B10 (>50,000hrs@Ta-30°C)
Beam Angle:	63°
IP Rating:	IP20
UGR:	<19
Efficiency:	>93%

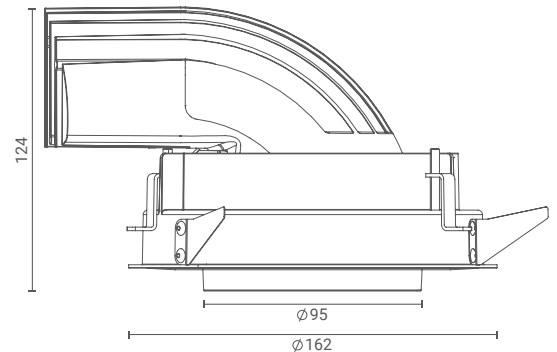

### Driver Specs :

Input:	220-240V ~50/60Hz
Driver Type:	On-Off/ Dali 2.0/ DT8.0/ BLE/ AD/ TD
THD:	<10%
Tunable & Dimmable:	Only Dimmable

