

Nova M

Recessed Downlight

Introducing ceiling-recessed downlight that highlight the desired subject or place and provide optimum illumination by being nondescript.

The simplicity of its form provides smooth integration in architectural features.



Product Specs :

Model name :	Nova M Recessed Downlight
Weight:	0.9Kg
Certificate Available:	Self Declaration Certificates
Colors Available:	Black / White
System Lumen:	3961 lm
System Wattage:	41 W
DC Current:	1050 mA
Efficacy:	97 lm/W
CCT(K) :	4000K
CRI:	> 90
Bining:	≤3SDCM
Lifetime:	L80/B10 (>50,000hrs@Ta-30°C)
Beam Angle:	21°
IP Rating:	IP20
UGR:	<19
Efficiency:	>93%

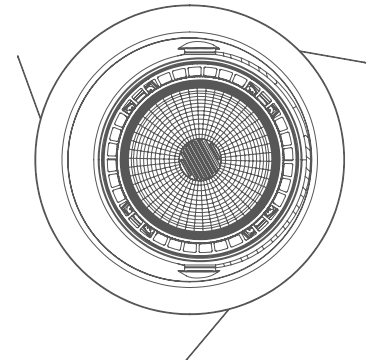
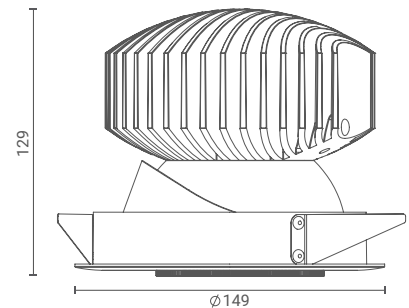

Driver Specs :

Input:	220-240V ~50/60Hz
Driver Type:	On-Off/ Dali 2.0/ DT8.0/ BLE/ AD/ TD
THD:	<10%
Tunable & Dimmable:	Only Dimmable

